



410 N Miller Ave, Gillette, WY 82716 www.newboces.org Cooperative Purchasing

NEW BOCES Co-OP

2024 COOPERATIVE PURCHASING CATALOG

Expansion and Innovation: Stay informed about new services, products, or initiatives that enhance our cooperative's offerings. Innovation is at the heart of our growth!

Thank you for being an integral part of Northeast Wyoming BOCES Cooperative. Together, we build a community that not only thrives economically but also fosters strong connections and shared values. Your participation and commitment make our cooperative a truly special place.



AEPA NEW BOCES is your one-stop shop for many of the things a school, town, county or non-profit needs, with full line of competitively bid products. We've done the leg work for you, following state-specific purchasing guidelines. And by combining the purchase power of those that we serve across the country, we've secured deep discounts on everything you need. AEPA NEW BOCES contracts are designed to protect buyers and are guaranteed to save you time and money. We streamline the bidding and purchasing process through a single locally and nationally recognized purchasing solicitation.

Here's how we do that:

- Each bid category consists of a team of member states that research and write the solicitation.
- The solicitation documents include AEPA and State-Specific Terms and Conditions to meet the purchasing guidelines in each respective state.
- Member states publish the bid advertisements locally according to their state laws.
- All Bid Documentation are provided on the website www.newboces.org under Co-operative Purchasing – Invitation to Bid.
- The Solicitation team ensures that each bid proposal is Responsive prior to evaluation.
- The bid category team reviews proposals and makes a recommendation for award.
- The 29-state local boards vote to approve the recommended awards.
- Once approved NEW BOCES enters into contracts with the successful vendors.
- The full board evaluates performance and votes on contract extensions annually, ensuring that vendors remain in good standing.

Membership Registration Form Page 67

2024 Contract Categories w/ Vendor Alphabetically:

Athletic Equipment & Supplies

Partac Peat Beam Clay pg. 14
School Specialty pg. 16

Athletic Lighting/LED Lighting

Facility Solutions Group pg. 22
Hellas Construction pg.10

Athletic Surfaces

AstroTurf pg. 7
Field Turf pg. 9
Hellas Construction pg. 10
Robert Cohen Sports pg. 17

Bleachers/Grandstands In/Out doors

MT School Equipment pg.12
Norcon pg.13

Career & Technical Education

BLICK pg.42
Pitsco pg.47

Custodial Supplies

Hillyard Inc. pg.24

Cellular Connectivity

Kajeet pg.57

Classroom Instructional /Digital Resources

Barnes & Noble pg.41
EPS Operations pg.43
Flinn Scientific Inc. pg.44
Mackin pg.45
Pitsco Education pg.47
Quill pg.37
ReThink Ed pg.48
SchoolsPLP pg.49
School Specialty pg.39
The OrganWise Guys Inc. pg.46

Digital Copiers

Konica Minolta pg.33
Kyocera pg.34

Digital Display Solutions

Daktronicspg.8
MT School Equipment pg.12
Norcon pg.13

Disaster Recovery

Service Master pg.27

EV Charging Stations

BLINK Network LLC pg.60
In-Charge Energy Inc. pg.61

CMMS (Facility Management Software)

Brightly pg.20
FMX pg.23

Furniture

AmTab pg.30
Demco pg.31
Meteor Education pg.35
National Business Furniture pg.36
School Specialty pg.39

Health & Wellness

School Health pg.38
TinyEYE pg.50

HVAC/MRO

Best Plumbing pg.19
Carrier pg.21
Lawson pg.25
LONG pg.26

Kitchen Institutional Equipment

Hubert pg.32

Office Supplies

Quill pg.37

Playground Recreation Equipment

Romtec pg.15
MT School Equipment pg.12

Roofing/Building Maintenance

Weatherproofing Technologies Inc.
(WTI) pg.28

Security Solution Products

Centegix pg.55
Deledao pg.56

Technology Buy Back

Total Technology pg.58

Technology Catalog

CDW-G pg.53
Bluum pg.52
Computer Professionals Unlimited
(CPU) pg.54

Vehicles

Chalmers Ford pg.66
Melloy— Chevy Ford Dodge Jeep pg.62
Pellegrino Auto Group pg.63
Peoria Ford pg.64
Phil Long Dealership pg.65



Index Sections

Athletics/Recreation pg.6-17

Facilities pg.18-28

Furniture/Office/Supplies pg.29-39

Instructional 40-50

Technology 51-58

Vehicles 59-66

Membership Form 67

Intergovernmental Agreement
Form 68-70

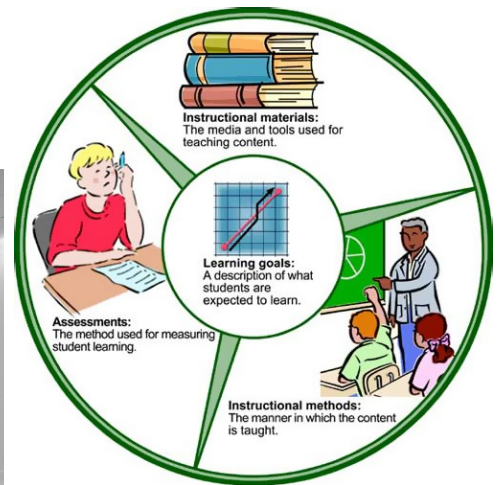

Athletic/Recreation

Equipment, Tracks, Courts, Fields, Bleachers, Lighting, Structures, Scoreboards, Signage, Supplies



AstroTurf Corporation

THE WORLD LEADER IN SPORTS & RECREATION SURFACES

AstroTurf.
FIELDS

Rekortan®
TRACKS

Laykold®
COURTS

SYNLAWN®
LANDSCAPE

AstroTurf Synthetic & Natural Surfaces Athletic, Playgrounds, Landscapes, Tracks and Courts

Contract# 024A-WY-102

Contact: Kim Summers (706)-264-1314 kim.summers@astroturf.com

Technology, quality, innovation, and legendary customer service— that’s what customers have come to expect from AstroTurf. Learn more about our history, products, projects, and ongoing innovations through our collection of videos.

[Baseball Tracks](#)

[Field Hockey Courts](#)

[Football Multipurpose](#)

[Lacrosse](#)

[Soccer](#)

[Softball](#)

[Multi-field Complexes](#)

When it comes to your kids, nothing is more important than their safety. We’ve developed the safest, most consistent playground surface anywhere.



Athletic turf technology is rapidly accelerating. That’s a good thing. It means that you’re more likely to find a product that will benefit your organization. There are more choices than ever before, between infills, pads, turf designs, companies, and more. But all of that choice can lead to “analysis paralysis”. The good news is that we have dedicated artificial turf consultants ready to help you navigate the complexities of this major investment. If you take a backseat through the process you might get stuck with something you don’t want.

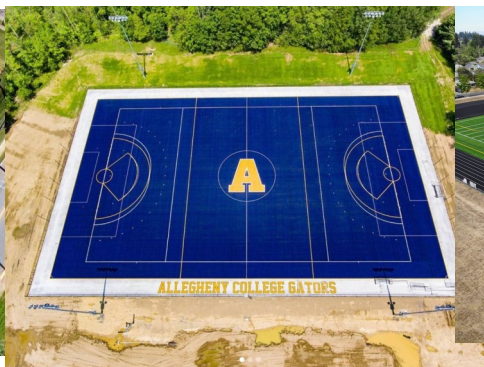



Daktronics Electronic Signs, Marques, High School Media Curriculum, Scoreboards
 Contract # 024F-WY- 101
 Ryan VanEarden 406-500-1183
 ryan.vaneardem@daktronics.com
 Lauren Cloud 605-692-0200 Ext. 56669
 lauren.cloud@daktronics.com

From high school scoreboards to major league video systems, roadside LED signs to iconic digital signage in Times Square, Piccadilly Circus and around the world, there's a good chance you see our products every day. What makes these customers choose, and keep choosing, Daktronics? We offer the industry's broadest range of products, deepest level of experience, highest level of performance, and unmatched customer service. Once you experience Daktronics, the difference is clear.

Cheyenne, WY



Central WY Fairgrounds



Sheridan College



Natrona High School



Field Turf Synthetic & Natural Athletic Fields, Playgrounds, Landscapes, Tracks and Courts

Contract# 024A-WY-101

Eric Fisher 503-708-6548

Eric.fisher@smartbuycooperative.com

Sarah Morehead 514-375-2584

sarah.morehead@fieldturf.com

- Make the most of your budget with total project solutions, including complete project design, construction and integration costs
- Ease the costs of your project with monthly, quarterly or annual payments to match the timing of fiscal budgets
- Costs are aligned to the systems useful life, allowing the playing surface to pay for itself over time
- Generally compatible with municipal financing annual budget appropriation requirements

Buffalo, WY



Douglas, WY



Evanston, WY





Hellas Construction, Inc. Synthetic Athletic Fields, Playgrounds, Landscapes, Tracks and Courts – Field Lighting
Contract# 024A-WY-103 (Fields, Playgrounds, Landscapes, Tracks, Courts)

021A-WY2025-1 (Field Lighting)

Ruth Hawley 512-250-2910

rhawley@hellasconstruction.com

Hellas is the nation’s leading turnkey sports contractor offering a complete scope of services including design/build, installation, and maintenance of sports surfaces, lighting, and amenities.

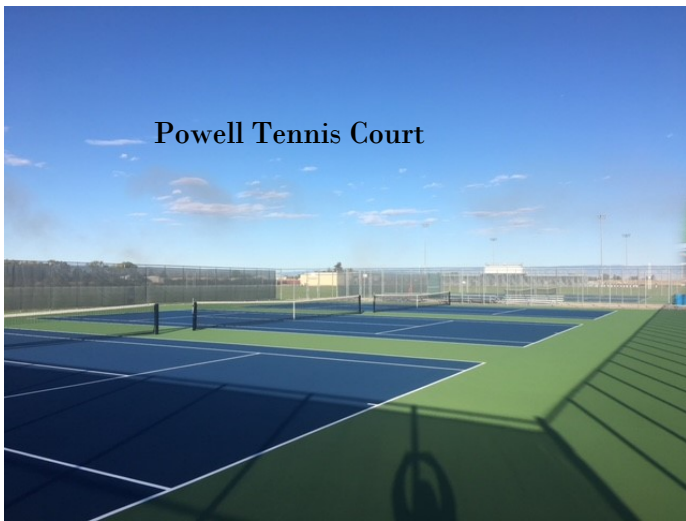

Powell Tennis Court



Pinedale Track



ROCK SPRINGS TIGERS

Riverton High School—Field & Track



Moorcroft High School



Pavillion High School

Coming Soon
New Playground Vendor(s)



Montana School Equipment – Bleachers & Grandstands
 Indoor & Outdoor – Playground Recreation Equipment –
 Digital Displays
 Contract # 02429WY-101
 Aaron Johnson 406 454-0420
aaron@mtschoolequipment.com

Products

- Auditorium/Lecture Room Seating
- Basketball Backstops
- Bleachers
- Gymnasium Divider Curtains
- Gymnasium Equipment
- Lockers
- Playground Equipment
- Staging/Choral Risers
- Wall Padding

We can provide you with everything from gym equipment, divider curtains, bleachers and basketball backdrops. Not to mention all the lockers in between.

Interkal

For indoor telescopic bleachers that are safe, built to last and have an outstanding appearance you cannot get any better than Interkal Bleachers, manufactured in their high tech, quality oriented factory in Kalamazoo Michigan.



Playcraft Systems

Playcraft Systems continues the quality and innovation as we have shown over the years.



List Industries, Inc.

As an innovator and industry leader in product design and development for over 60 years, List Industries continues to lead the way into the next millennium.

With our abundant selection of both production and stock lockers, you are sure to get the features you need.



Draper Inc.

Draper offers three directions to fold the backstop — forward, back or to the side—giving you a 360° choice of which way to take the backstop up and out of play.

Norcon



Norcon – Bleachers Stadium Seating, Staging Concepts, Digital Displays, Lockers, , Recreation Equipment

Contract# 02429WY-102

Guy Parker 505-343-8801

guy.p@norconnm.com

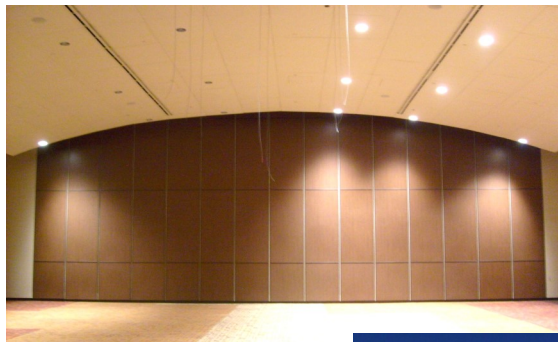

Products Include:

Auditorium & Stadium Seating, Gym Bleachers & Wall Pads, Basketball Goals, Lockers, Scoreboards, Stage Curtains, Partitions; Operable and Vertical Retractable

We are a full-service architectural specialty product distribution firm specializing in educational, institutional, hospitality, church, and commercial projects. From the servicing of existing products; to orchestrating multi-product installations; to the fast track completion of major multi-site projects.

Our skilled team is dedicated to earning your repeat business. In addition to direct customer service, we offer professional architectural consulting for your specification writing, budgeting, and design implementation needs.



Your One-Stop Source for America's Leading Sports Surfaces & Supplies!

• Baseball / Softball

- Regional Infield Mixes, Mound Clays, Home Plate Clay, Warning Tracks, Top-Dressing, Diamond Dry, In-field Conditioners

- Infield Grooming Equipment

- Batting Practice Mats

- Portable Pitching Mounds

- Bases, Home Plates, Pitching Rubbers, Anchors, Base Plugs, Dig-out Tools

- Field Marking Materials & Equipment

- Foul Poles

- Field Rain Covers: Mound, Home Plate

- Aluminum Benches, Scorer's Tables

- Aluminum Bleachers

- Backstop, Wall, Rail & Post Padding Fence Guards, Corrugated Fence Topper, Poly-Cap, Fence Crowns, Safety Top Caps, Foam Guards, Rail Padding

- Windscreen, Distance Banners, Dugout Shelters, & Backdrop Protectors

- Ball & Barrier Netting / Ball Stopper Systems

- Synthetic Turf for Batting Tunnel Mats, Dug-out Areas, Walkways

- Natural Clay & Fast-Dry Surfacing

- Cricket

- Pitch Clays

- Turf Blankets, Sideline

- Covers, Football Goals, Goal Post Protector Pads, Footballs, Agility & Strength Equipment

- Soccer Goals, Nets, Corner Flags, Soccer Balls

- Horseshoe & Quoit Pit

- Clays & Equipment

- Rubber Granules

- Track Protection, Long Jump Pit Sands, Shotput Sector Surfacing

- Volleyball

- Sands & Equipment

- Gym Floor Protection, Gym Mats, Wall Padding, Gym Divider Curtains

- Dog Park Agility Equipment





Romtec Inc. Restroom/Concession
Structures Parks Recreation
Contract# 019.5B-003NB
Kris Lamar 541-496-3541
Klamar@romtec.com

Founded on strong engineering and a passion for quality, Romtec designs finished products that make our customers proud.



Romtec provided a large multi-user restroom along with (2) single-user restrooms and attached pavilion

Romtec restroom that has two unisex single user restrooms, a mechanical room, and a timber truss roof extension. The building has a matching wooden theme that fits well into this wooded play area and park.



Romtec provided a new 2-stall multi-user restroom with a mechanical room



School Specialty- SporTime Athletic Equipment

www.schoolspecialty.com/AEPA-co-op
 023G-WY-2028-2 (Athletic Equipment)
 Belkys Quintana
 belkys.quintana@schoolspecialty.com
 786-314-8017

Adapted PE	Balls	Exercise - Fitness Equipment	Climbing Equipment	
Goals	Mats	Gymnastics	PE - Health Resources	PE Games - Activities
PE Sets - Packs	Recreation - Recess		Sports	Obstacle Course Equip-

We know that for you, your mission, your calling, is to make sure that when your students walk into school each day, they have everything they need to build their confidence, ignite their imaginations and realize their potential. Finding just the right products and learning materials. It can take all of your time. And more than your budget.

That's why we've made it our mission to engage and inspire, with everything from crayons to curriculum to complete learning environments. We offer you solutions for every category from STEAM to safety. And help you make the most of your funding for it all.





Sport Surfaces Athletic Surfaces, Mondo/Hardwood Flooring, Synthetic Turfs, Tracks, Courts
Contract# 021B-WY2025-1 (Hardwood/Mondo Athletic Flooring)

Robert Cohen 505-243-2971
rcohen@sport-surfaces.com

Multi-Purpose

Tracks

Tennis & Pickleball

Gymnasiums

Weight & Fitness



Facilities

Software, HVAC, MRO, Equipment, Supplies, Building Maintenance

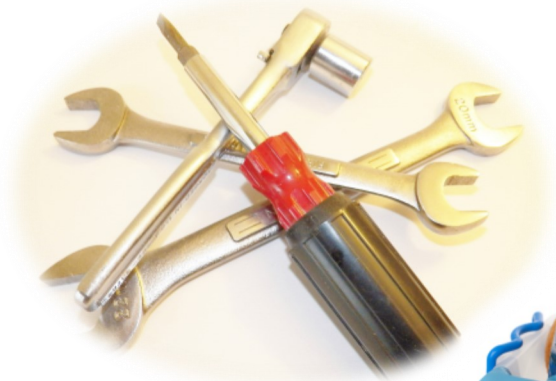

Contract # 023A-WY-2028-3

Amber Carr

(800) 448-6710 ext. 8155

contracts@bestplumbingonline.com



We proudly maintain a large selection of national contracts with Government and Educational Purchasing Cooperatives on the Federal, State, and Local levels.

These contracts entitle users to our value-added services at no additional charge, which includes inventory management solutions, customizable kit box assortments, and product research to identify fixtures and hard-to-find or obsolete repair parts.





Brightly Facility Management Software
Contract# - 024D- WY-102 CMMS
Andrew Connors
919-418-3399
Adrew.Connors@Brightlysoftware.com
Sales Rep: Matt Hibbard 919-459-
3347Matt.Hibbard@Brightlysoftware.com

Enterprise Asset Management Solutions & Operations Software



Get to know the ins and outs of your next software solution

Comprehensive Asset Management & IoT Software Solutions

Brightly pairs its complete suite of user-friendly software—including CMMS, EAM, Strategic Asset Management, IoT Remote Monitoring, Sustainability and Community Engagement—with tailored consultancies and award-winning support services to light the way to a bright future where we can all thrive.

FACILITY
MANAGEMENT





Carrier HVAC Parts Products Supplies Service
 Contract # 021.75-WY202125
 Daniel Gonzales 949.226.2097
 daniel.gonzales@carrier.com

[Airside](#)
[Air Handlers](#)

[Air Terminals](#)

[Beams](#)

[Coils](#)

[Fan Coils](#)

[Induction Units](#)

[Unit Ventilators](#)

[Chillers & Components](#)
[Air-Cooled Chillers](#)

[Water-Cooled Chillers](#)

PRODUCTS

About IoT Platform

Airside

Chillers & Components

Controls

Ductless Systems

Packaged Indoor

Packaged Outdoor

Split Systems

Parts & Supplies



Packaged Indoor/Outdoor Units



Variable Refrigerant Flow



Ductless Systems

FSG LIGHTING

LED Lighting Supplies
Contract# 022EWY20261
Alyssa Mika
855-642-1109
Email aepa@fsgi.com



Lighting

Lighting Retrofits	Lighting Design
Sports Lighting	Lighting Design & Specification Support
Lighting Audits	Turnkey Retrofit Solutions
MRO Supply	New Construction Lighting Packages
Waste Recycling Computer-Aided	Lighting Upgrades for Energy & Maintenance

ELECTRICAL

Aerial Work	Planned Lighting Maintenance
Interior & Exterior Maintenance	Electrical Contracting
Site Lighting	Service & Gear Upgrades
Electrical Service & Repair	Nationwide Capabilities
Infrared Scanning & Thermal Certifications	

BALLASTS/ DRIVERS	GLASSWARE/GLOBES	PHOTOCONTROLS
BATTERIES	HARDWARE	POLES/FITTERS
CONTROLS	LAMP CHANGERS & HOLDERS	WIRE CONNECTORS
FIXTURES	METERS	WIRE DEVICES



Facility Management Express (FMX) Facility Management Software
Contract# 024D-WY-101 CMMS
Marc Stitt 614-309-5998
marc.stitt@gofmx.com

The FMX story

At the time, the school we were working with was trying to find a way to easily manage their facilities remotely while maximizing energy savings. We began searching for software that was capable of scheduling preventive maintenance, streamlining event scheduling, and tracking maintenance requests. While many options were available, none helped us achieve our needs and were far too complicated for staff members to use on a daily basis. We knew we could create something better, so we did.

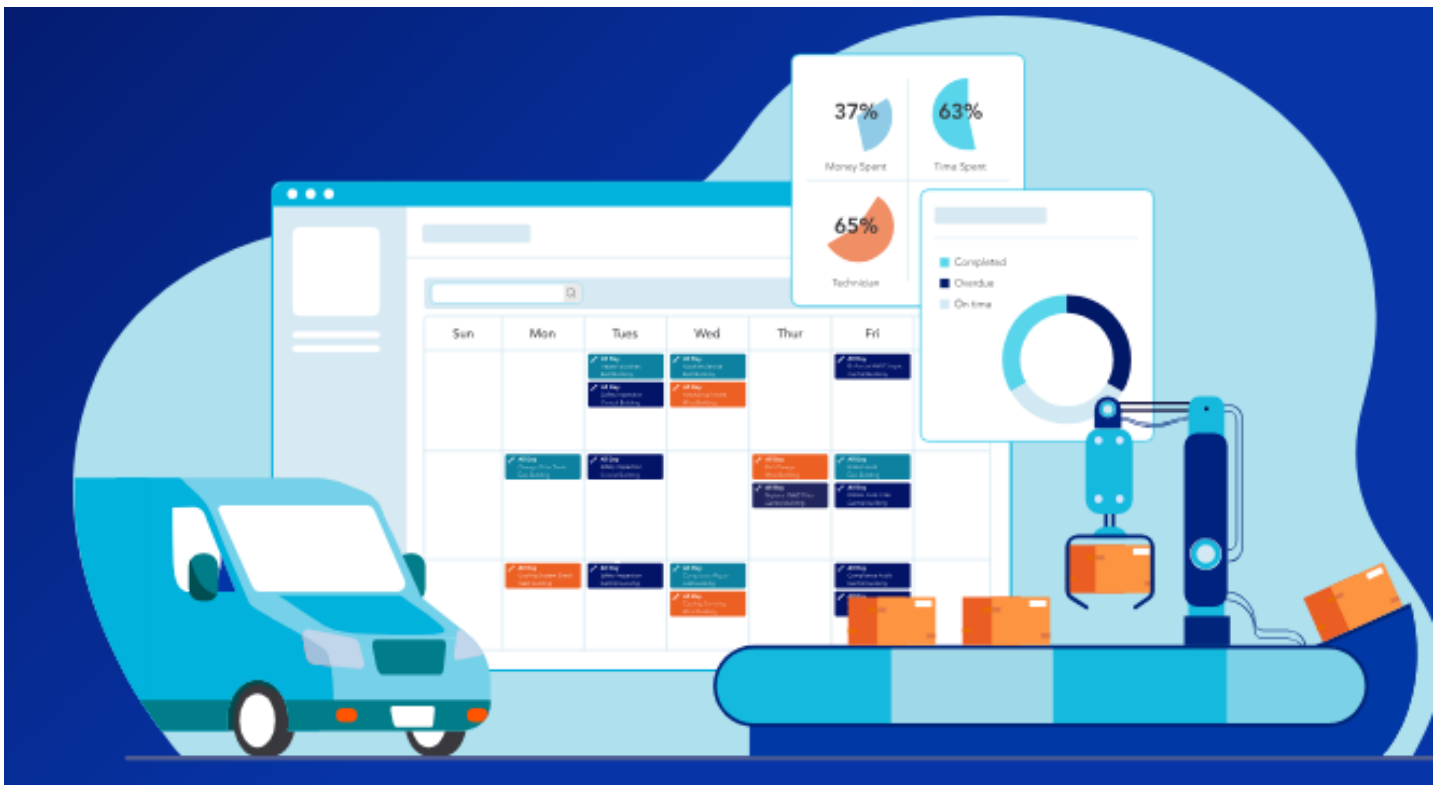

Increase asset lifespans and strategically plan the use of your equipment with reliable maintenance software.

HILLYARD

Hillyard Custodial Equipment & Supplies
 Contract# 023B-WY-2028-1
 Matt Johnston Mobile 816-383-8362
 mjohnston@hillyard.com

[Chemicals & Dispensing](#) (755)

[Cleaning Equipment](#) (6,499)

[Cleaning Tools](#) (1,760)

[Buildings & Grounds Maintenance](#) (101)

[Floor Pads](#) (507)

[Food Service](#) (122)

[Gloves, Matting & Safety](#) (317)

[Hand & Personal Care](#) (673)

[Laundry & Warewash](#) (97)

[Odor Control](#) (223)

[Paper](#) (602)

[Trash Bags & Liners](#) (529)

[Waste, Recycling & Material Handling](#) (669)

[Consumables, Parts & Accessories](#) (6,094)

[Floor Squeegees](#) (54)

[Steam Cleaners](#) (3)





Lawson – Our customers have “the right part in the right place at the right time.” Lawson’s Vendor Managed Inventory program minimizes capital investment in inventory while providing “package friendly” quantities that assure maximum productivity.

Contract # 023A– WY - 2028 – 2

Dan Oliver Dan.Oliver@lawsonproducts.com Mobile: 941-219-9902

ABRASIVES

AUTOMOTIVE

CHEMICALS

CUTTING TOOLS

ELECTRICAL

FASTENERS

FLUID POWER

MATERIAL HANDLING

SAFETY

SHOP SUPPLIES

HAND TOOLS

STORAGE EQUIPMENT

WELDING





LONG – HVAC/MRO Contract# 023A-NBWy-2028
Jeremiah Kidd, 307-265-5997
jkidd@long.com

We combine the best in commercial building automation, HVAC equipment, HVAC service and parts to provide a custom solution for maximum building performance and peace of mind.

Our experienced team will partner with you through the design phase of your commercial project to ensure you receive the right solution for your specific needs. We understand that each project is unique, and no two HVAC systems are the same, so we work closely with MEP consulting engineers to develop the optimal solution for your project's design conditions and criteria.

- | | | |
|----------------------------------|----------------------------------|-----------------------------------|
| Air Filters | Fin-Tube Radiant Heating Systems | PTAC Units |
| Air Handling Units | Flow Control Valves | Pumps |
| Blower Coils | Fume Hood Control Systems | Radiant Panels |
| Boilers | Grilles, Registers, Diffusers | Refrigerant Monitoring Systems |
| Cabinet Heaters | Gas-Phase Filtration | Rooftop Units |
| Chilled Beams | Heat Exchangers | Rooftop Ventilators |
| Chillers | Heat Pumps | Skid-Mounted Pumping Systems |
| Coils | Heat Recovery Systems | Solar Panels |
| Coil Piping Packages | Humidifiers | Sound Attenuators |
| Condensing Units | Hose Kits | Spiral Duct |
| Cooling Towers | Infrared Heat | Steam Heating Systems |
| Custom Air Handling Units | Kitchen Ventilation Systems | Thermal Storage Systems |
| Dampers and Louvers | Make-Up Air Units | Thermally-Operated Air Diffusers |
| Displacement Ventilation | Mini-Split Systems | Under-Floor Air Distribution |
| Dust and Mist Collection Systems | MRI Cooling Systems | Underground Ductwork |
| Energy Recovery Systems | Packaged Chiller Plants | Unit Heaters |
| Expansion Tanks | Packaged Rooftop Equipment | Variable Frequency Drives |
| Evap Coolers | Plate and Frame Heat Exchangers | Variable Refrigerant Flow Systems |
| Fans – Commercial and Industrial | Precision Air Conditioning | Vibration Isolation |
| Fan Coil Units | | Water Heaters |
| | | Water Treatment |





ServiceMaster of St. Cloud, Inc. Disaster Recovery
Contract# 021F-WY2025-1
Trent Herman
Office: 800-245-4622 | Mobile: 320-292-4373
trenth@svmps.com

The damage or destruction of property due to unexpected disaster can be devastating for anyone. In many cases, the damage sustained is more severe than you could have even planned for. Whether your property requires repair because of a fire, flood, or weather event, time is of the essence.

- Commercial pre-loss planning
- Water damage repairs
- Fire and smoke damage repairs
- Weather damage repairs
- Mold remediation
- Emergency restoration





Weatherproofing Technologies (WTI) Tremco

Exterior Building Maintenance & Roofing

Contract# 021D-WY2025-1

Bryan Pulliam (307) 228-4809

bpulliam@tremcoinc.com

Products

[Accessories](#)

[Air and Vapor Barriers](#)

[Coatings](#)

[Cold Applied Built-Up Roofing Products](#)

[Deck Accessories](#)

[Flashings](#)

[Hot Applied Built-Up Roofing Products](#)

[Insulation/Fasteners](#)

[Liquid Applied Roofing Products](#)

[Maintenance Products](#)

[Mastics/Primers/Sealants](#)

[Metal Roofs and Walls](#)

[Modified Bitumen Roofing Products](#)

[Safety](#)

[Single Ply Roofing Products](#)

[Vegetated Roofing System Packages](#)

Roofing Systems

[Cold Applied Built Up Roofing Systems](#)

[Hot Applied Built Up Roofing Systems](#)

[Liquid Applied Roofing Systems](#)

[Metal Roofs and Wall Systems](#)

[Modified Bitumen Roofing Systems](#)

[Photovoltaics](#)

[Roof Restoration](#)

[Single Ply Roofing Systems](#)

[Vegetated Roofing Systems](#)

[Detail Drawings](#)

[Detail Drawings \(Redirect\)](#)

Markets We Serve

[Architects](#)

[Education](#)

[Cooperative Contracts](#)

[Contractors](#)

[Federal Government](#)

[Healthcare](#)

[Manufacturing](#)

[National Accounts](#)



Furniture

Office

Office





Design • Manufacture • Furnish

Furniture and Signage Graphics Decor

AMTab Manufacturing Designs, manufactures and furnishes high-impact learning environments and student cafeterias. All products are 100% made in the USA. AmTab Manufacturing Corporation is a leading innovator in the K-12 Dining Commons and Food Courts marketplace providing customized tables, mobile booth systems, interior décor signage and branding. Additionally, our catalog includes furniture for classrooms, STEM environments, music and performance spaces, and waste & recycling receptacles.

Contract# 022AWY20264

Greg Swon 630-301-7600

Mike Schwab

greg.swon@amtab.com

mike.schwab@amtab.com

[Spaces](#)

[Signage, Graphics, and Decor](#)

[Dining Tables & Booths](#)

[Eating Counters & Column Wraps](#)

[Booth Systems](#)

[Mobile E-Z Tilt Tables](#)

[Mobile Bench Tables](#)

[Mobile Stool Tables](#)

[Mobile Stool & Bench Tables](#)

[Mobile Shape Tables](#)

[Mobile Conversation Tables](#)

[Social Tables](#)

[Receptacles, Condiment Cabinets & Partitions](#)

[Mobile Buffet Tables](#)

[Classroom Tables & Desks](#)

[Music & Performance](#)

[Seating Concepts](#)

[Conference & Training Tables](#)



Winged Configuration





Demco Inc. Furniture - Helps educators spark curiosity & ignite learning by equipping schools and libraries w/ inspired furnishings, space design, innovative learning tools, top quality supplies & equipment. Contract # 022AWY20263

Purchase# C10903

Laura Betz
608-242-2397
LauraB@Demco.com

Our Services

No matter what you need, a friendly and responsive Demco representative is ready to help. We bring decades of experience and extensive resources together to support you and your community.

Use our free grants database to find current available grants without the cost of an expensive subscription.

Use NEW BOCES purchasing contract and feel confident you've gotten fair prices on products that meet district requirements. Plus, you'll avoid the bidding process!

Furniture for libraries, schools, and classrooms

Create a place where connection, innovation, and growth come first! From flexible seating and desks to STEM-friendly tables and storage, the future-focused solutions for library furniture, school furniture, and classroom furniture





Hubert Kitchen Equipment Institutional Equipment,
Food Prep Smallwares, Labels, Serveware/
Displayware, Shelving, Racks & Floor Fixtures, Table-
ware, Transport & Storage
Contract# 0225C-WY-001
Karen Waldron [276-970-0195](tel:276-970-0195) kwaldron@hubert.com

- Apparel & Protective Clothing
- Bakeware
- Bar & Beverage
- Catering and Buffetware
- Collections
- Cookware
- Countertop Fixtures
- Décor
- Equipment
- Food Prep Smallwares
- Foundations and Elevations
- Healthcare
- Health & Safety
- Labels
- Maintenance
- Merchandising Trends
- Operations
- Packaging
- Serveware/Displayware
- Shelving, Racks & Floor Fixtures
- Signage
- Tabletop Buffet Fixtures
- Tableware
- Transport & Storage





Konica Minolta Mystem Kits, Cloud Printers, Catalog Products, Visitor Management System Software
Contract# 021C-WY2025-1
Marc Biga
720-290-2431 mbiga@kmbs.konicaminolta.us

KONICA MINOLTA

The scope of the contract is the purchase and/or lease of digital multi-function devices/copiers, printers and related accessories, service and supplies, and solutions, including managed document services from equipment manufacturers. Non-participating states may piggyback another states contract as governed by state statutes.





Kyocera Printers Copiers
Contract# 021C-WY2025-2
Dan Woolly 214-557-5207
dan.woolly@da.kyocera.com

Kyocera's products are renowned for their unique long-life imaging components that provide greater reliability and less waste - resulting in a lower Total Cost of Ownership (TCO) over the life of the product all due to the use of the unique Kyocera developed amorphous silicone drum Kyocera Document Solutions Inc. is a core company of Kyocera Corporation, the world's leading developer and manufacturer of advanced ceramics which is the major component of the amorphous silicone drum.





MeTEOR Education, LLC Furniture Turn-key Services from Space Design and Optimization, Environment Orientation, Post-Occupancy Configuration, and High Impact Learning Experience Training & Consultation.

Contract # 022AWY20266

Lanie Hart 800-699-7516

lhart@meteoreducaiton.com

As one of the largest providers of learning environments, including furnishings and interior design services, Meteor’s focus is the integration of best practices for teaching and learning to drive inquiry-based instruction, effective use of modern classrooms, and increased student achievement. We firmly believe that in order to best serve the schools we work with, we need to be members in the community. Your local Meteor team benefits from national resources and thought leadership while also providing dedicated local team support that makes a difference.





**NATIONAL BUSINESS
FURNITURE**

National Business Furniture Office Classroom

Building Furniture

Contract# 022AWY20262

Joanna Terry

800-558-1010

800-329-9349

joannat@nbf.com

Government

Education

Healthcare

Hospitality

Workplace

Seating

Tables

Storage

Cubicles & Workstations

Accessories

Desks





Quill - Office/Classroom/Instructional Supplies
 Contract#
 023C-WY-2028-1 (Office Supplies)
 023D-WY-2028-6 (Instructional Supplies)
 Samra Cejvan 847-876-5451
samra.cejvan@quill.com

- Custom pricing on hundreds of items
- Category discounts of up to 20%
- Free shipping—no minimum
- Technology, furniture, and custom-print specialists are available to assist you with projects and help you maximize savings

Wyoming



Quill is partnered with Northeast Wyoming BOCES and AEPA to help you save on the supplies your school uses most. There are hundreds of custom-priced items, free shipping, and more. Plus, technology, furniture, and custom-print specialists are here to help you.

- 20% discount on imprinted products
- 15% discount on office, school, and instructional supplies
- 10% discount on cleaning and breakroom supplies
- 10% discount on ink and toner
- 10% discount on furniture
- 5% discount on calculators
- 5% discount on computer peripherals and office machines
- Additional large volume discounts on category discount items

Your custom pricing automatically appears on Quill.com when you log in with an account that's paired with your AEPA co-op. If you need help creating an account, call us at 800.982.3400.

Desk accessories & organizers	Folders & filing	Storage & organization	Post it & sticky notes		
Envelopes	Calendars & planners	Clips & fasteners	Binders	Ruled pads	Notebooks
Dividers	Sheet protectors	Tape & adhesives	Staplers	Flags & tabs	Stamps
Calculators	Label makers & tapes	Address labels	Shredders	Laminating machines	
Easel pads	K-Cups Cups, plates, bowls & cutlery, Candy, Coffee, Creamers, Sweeteners Beverages Food & snacks Condiments Water Coffee makers Gum & mints Stirrers & straws				

Copy & multipurpose	Colored paper	Composition & notebooks	Cardstock	Legal paper		
Laser paper	Stationery & invitations	Inkjet paper	Art paper & rolls	Post it & sticky notes		
Forms	Construction paper	Index cards	POS paper	Filler paper	Poster boards	Resume paper



School Health Medical Products Health & Wellness

Contract# 022BWY20261

Jennifer Lovell 630-339-7993

jlovell@schoolhealth.com

Child Development Centers Contact:

Timothy Talty

talty@schoolhealth.com

- Deep discounts on our most popular items
- 13% off all other items on the site (limited exclusions apply)
- Free shipping on orders over \$125.00
- Friendly and professional customer service

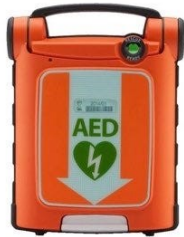



School Specialty- Education Essentials/Classroom/ Office Products, SSI Guardian Products, Hand held Metal Detectors, SporTime Athletic Equipment
www.schoolspecialty.com/AEPA-co-op
 Contract #
 023D-WY-2028-3 (Instructional Supplies)
 023G-WY-2028-2 (Athletic Equipment)
 022AWY20261 (Furniture)
 Belkys Quintana
belkys.quintana@schoolspecialty.com
 786-314-8017

Save Time & Money - Utilize Your AEPA/NEW BOCES Contract

School Specialty is pleased to offer you the benefits of a competitive purchasing contract through AEPA/NEW BOCES

Products

Awards - Incentive	Backpacks - Bags	Binders - Accessories	Book Covers - Repair
Calculators	Classroom Decorations	Classroom Storage	Daily Planner - Calendars
Desk Accessories	Dry Erase Boards - Lap Boards	Folders - Filing	Ink - Toner
Labels - Labeling	Measuring - Drafting	Office - School Forms	Office Equipment - Supplies
Paper	Pencil Sharpeners	Research Books - Reference	Scissors - Cutting
Shipping - Mailing	Tape - Mounting	Timers - Stopwatches	Writing Supplies

School & Office Supplies to Fit Every Budget

Audio Visual	Boards	Cafeteria	Carts	Computer Furniture	Desks	Displays
Early Childhood	Easels	Floor Coverings	Gym Equipment	Learning Environment Decor		
Library - Media Center	Performing Arts	Room Dividers - Partitions	Seating	Signing		
Storage	Tables					

Instructional Classroom



BARNES & NOBLE

Barnes & Noble Instructional Digital Resources - Books, eBooks, Audio Books, Music & Movies, Educational Toys & Games, STEM & STEAM Products. All members will have an assigned local Business Development Manager and store team to assist them with all their need.

Contract# 024C-WY-106 DR

Jessica Pelzer

212-414-6001

jpeltzer@bn.com

Taking advantage of vast warehouses across the United States, we stock over 1 million titles for immediate delivery -- that's more titles than any other online bookseller.

With so many titles, it is vital to give customers an easy way to find precisely the books they are looking for. Our search engine enables customers to locate books by title, author, or keyword in a few seconds at most. Customers with a general idea of what they want can use our Browse pages to sift through hundreds of categories to find exactly the right book. To further assist users, we offer descriptions and reviews, and our See Inside program lets customers read excerpts from tens of thousands of titles. We also offer editor recommendations and customer reviews on hundreds of thousands of titles.

[Barnes & Noble Kids](#) is the ideal destination for anyone looking for the best in children's books, videos, and music. With age-based recommendations, as well as specialty stores that cater to Harry Potter and other big titles, it's the ultimate one-stop shop for kids.

Our [DVD & Blu-ray Store](#)'s 60,000+ titles make it the destination of choice for movie lovers, whether they enjoy Blockbusters, Art House rarities, or Kids' favorites. You can view more than 10,000 full-length previews -- and instantly order what you have seen -- making it the most customer-friendly site around.

Our [Music Store](#) has been named the Web's best by Forbes.com. The premier site for Classical, Jazz, Rock, and World music, the store's rich content includes exclusive interviews, free downloads, over 1 million sample audio clips, nearly 100,000 music reviews, and a roster of 40,000 artist biographies.

In recent years we've added new product lines, expanding our [Toys & Games](#) store on the Web; a [Magazines](#) store, filled with exclusive and hard-to-find titles offering thousands of subscriptions.





BLICK® art materials



Contract Benefits

20%* Discount off “Each” price as listed in BLICK *Materials for Art Education* printed catalog.

Free shipping on most orders over \$49*

* Exclusions Apply

Be sure to reference [Contract Code](#)

QD20AEP for Contract Pricing

How to Order

Email: PurchaseOrders@dickblick.com

Fax: (800) 621-8293

Phone: (800) 447-8192

Online: DickBlick.com

Mail: PO Box 1267, Galesburg, IL 61402

Request a Quote

Megan Miller – RegionEQuotes@dickblick.com

School Supplies - Art Supplies

Painting Supplies

Paints, Canvas, Brushes

Drawing Supplies

Pencils, Markers, Crayons

Pastels, Graphite, Charcoal

Papers

Construction, Kraft Rolls, Tissue

Drawing, Tracing, Mixed Media

Specialty Papers

Crafts

General Crafts

Fiber Arts, Sewing, Weaving

Mosaics, Basketry, Jewelry Making

Printmaking

Inks, Blocks, Tools

Sculpture & Ceramics

Clay, Glazes, Tools

Kilns, Wheels, & More

Equipment & Furniture

Easels

Tables, Stools

Industrial Arts & Career and Tech Supplies

Drafting & Design

Rulers, Protractors, Triangles

Compasses, Curves

Scale Model Supplies

Technical Pens & Markers

Vellum, Layout, & Tracing Papers

Airbrush & Specialty Painting

Airbrushes & Replacement Parts

Compressors

Spray Booths

Paints, Stencils, Films

Enamels, Pinstriping

Screen Printing

Inks

Frames, Screens, Squeegees

Screen Printing Machines

Equipment & Furniture

Drafting Tables

Lighting

Die Cutting



EPS Operations Educational Digital Resource

Contract# 024C-WY-105 DR

Mark Esstman 336-406-2649

Mark.Esstman@EPSLearning.com

Brent Goodman, 603-579-3437

Brent.Goodman@EPSLearning.com



The EPS Literacy Framework is anchored to the Science of Reading, making it easy and effective for teachers to meet the needs of every student PreK-12 in every tier and with every reading skill.

FLINN SCIENTIFIC

Flinn Scientific Instructional Digital Resources for
Science

Contract # 024C-WY-101DR

Sally Lovell 630-389-3828

Slovell@flinnsci.com

[NEW PRODUCTS](#)

[APPARATUS](#)

[BIOLOGY](#)

[CAREER AND TECHNICAL EDUCATION](#)

[CHEMICAL STORAGE CABINETS](#)

[CHEMICALS](#)

[CHEMISTRY](#)

[CLEARANCE ITEMS](#)

[EARTH & ENVIRONMENTAL SCIENCE](#)

[FLINNPREP](#)

[FORENSIC SCIENCE](#)

[LAB FURNITURE](#)

[PAVO BUNDLES](#)

[PHYSICS & PHYSICAL SCIENCE](#)

[SAFETY SUPPLIES](#)

[SCIENCE2GO](#)

[STEM EDUCATION](#)

[TECHNOLOGY](#)

[3D PRINTERS](#)

[BOOKS & REVIEW MATERIALS](#)

[CALCULATORS](#)

[DOCUMENT CAMERAS](#)

[FORCES & EQUILIBRIUM](#)

[INTERFACE SYSTEMS & SOFTWARE](#)

[MOMENTUM & COLLISIONS](#)

[MOTION](#)

[SENSORS](#)

[SIMPLE MACHINES](#)

[TECHNOLOGY LAB MANUALS](#)

[TECHNOLOGY STARTER KITS](#)

[AGRICULTURAL](#)

[CODING AND ROBOTICS](#)

[HEALTH AND MEDICAL SCIENCES](#)

[WHITEBOX LEARNING](#)

[BOOKS & REVIEW MATERIALS](#)

[CHARTS & POSTERS](#)

[CHEMICAL DEMONSTRATION KITS](#)

[CHEMISTRY OF TOYS](#)

[STEM DESIGN KITS](#)

[CHEMISTRY KITS](#)

[GAMES & PUZZLES](#)

[GENERAL, ORGANIC AND BIOLOGICAL CHEMISTRY](#)

[GLASSWARE & PLASTICWARE](#)

[LABORATORY SUPPLIES](#)

[MEASUREMENT & DENSITY](#)

[MICROSCALE CHEMISTRY](#)

[MODELS](#)

[PERIODIC TABLES](#)

[SCIENCE CHEMISTRY LAB KITS](#)

[ANATOMY & PHYSIOLOGY](#)

[ANIMALS](#)

[BIOCHEMISTRY](#)

[BIOTECHNOLOGY](#)

[BOOKS & REVIEW MATERIALS](#)

[CELLS](#)

[CHARTS & POSTERS](#)

[CLASSIFICATION & TAXONOMY](#)

[CTE & NURSING](#)

[EVOLUTION & ECOLOGY](#)

[STEM DESIGN KITS](#)

[ONLINE STUDENT PREP COURSES](#)

[GENETICS & DNA](#)

[MICROBIOLOGY](#)

[MICROSCOPES, STE-REOSCOPES & SLIDES](#)

[PLANTS](#)

[PROTOZOA](#)

[VIDEOS](#)

[VIRUSES & EPIDEMIOLOGY](#)



Mackin - Educational Digital Resources

Contract# - 024C-WY-102DR

Judith Christianson

judith@mackin.com

Andy Wills 701-404-0279

As the needs and demands of education evolve, and in-class and remote learning becomes part of the norm, MackinVIA continues to anticipate and respond with an intelligent array of state-of-the-art features.

Digital Print

Library

Classroom

Makerspace

PD

eBooks

Audiobooks

Databases

Videos

Digital Subscriptions

Shared Digital Collections

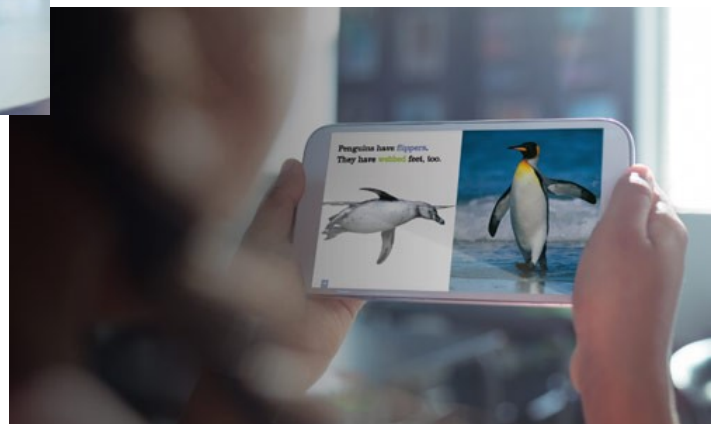
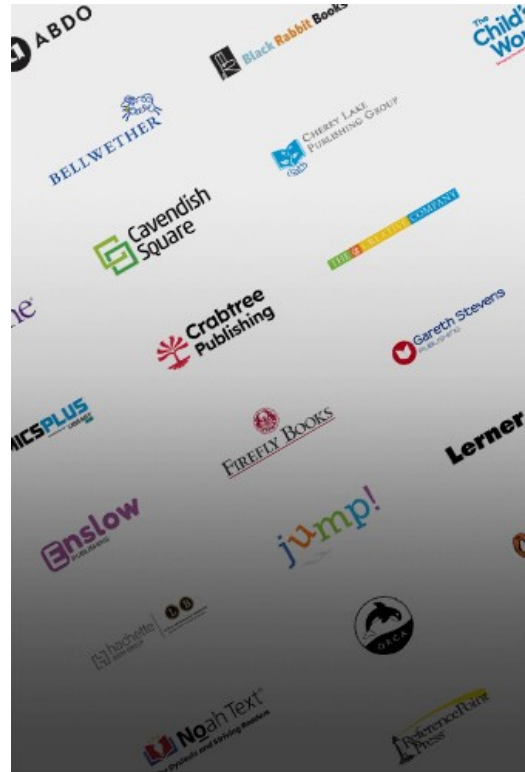



Organ Wise Guys Educational Digital Resource
Contract# 024C-WY-103 DR
Michelle Lombardo 770-495-0374,
800-786-1730 x6 michelle@organwiseguys.com

EMPOWERING KIDS

to be Healthy and Smart from the Inside Out!

An evidence-based program shown to improve children's health and academic performance!

The OrganWise Guys is ready-to-go programming designed for busy educators who are committed to improving children's health. Complete with lesson plans, implementation guides, and complementary online trainings, onboarding is simple, yet the results are measurable.

- Improves children's health in a statistically significant manner
- Improves literacy and test scores
- Addresses social and emotional health
- Is linked to STEM, Health & PE and state-specific academic standards
- Has both digital and physical resources
- Content in English and Spanish
- Includes pre/post tests and a data usage collection tool
- Is flexible and easy-to-implement

Is included in the [USDA's SNAP-Ed PSE Toolkit](#) (Research-Tested Program)





Pitsco Educational Supplies Career & Technical Education (STEAM)

Contract# 022.5-B-WY-002

Ben Arnold barnold@pitsco.com

Angela Watson 800-835-0686

awatson@pitsco.com

We Aim to Deliver Transformative Learning Experiences that Prepare Students with Future-Ready Skills.

Pitsco Education has 50 years of experience providing innovative, hands-on curricula. Our academ-

ic, STEM, and career-based solutions offer proven programs that address core standards while providing students with tangible, kinesthetic experiences and real-world applications.

Through our programs, students experience a combination of teacher-led instruction and student-directed learning using a blend of strategies and delivery

methods. Not only do students engage in learning, but they also acquire and strengthen their knowledge throughout a variety of hands-on, true-to-life projects and themes.

All our career-focused STEM curricula integrate a variety of college- and career-readiness skills while providing academically relevant learning opportunities for students in PreK through Grade 9.



We enable young learners to develop the mind-set, skill set, and tool set needed for future success.



Our PreK-2 STEM Programs are designed to prepare students for the real world. This means we provide lots of time within our program for collaboration and hands-on activity without sacrificing teacher-led instruction and independent work.



The overall goal is to engage little learners and provide playful learning and multisensory instruction. These activity bundles encourage collaboration and social-emotional learning for the learner and provide cross-curricular differentiated instruction for the educator.



RethinkED Digital Resources
Contract# 024C-WY-107 DR
Mike Kisow 646 630-3101
mike.kisow@rethinked.com

Together We Power the Potential of All Learners



RethinkEd’s innovative solutions create healthy school climates, promote a greater awareness and understanding of mental health and wellness, and empower educators with training and instructional tools that drive whole school success.

Personal Wellness

Support your educators and staff build emotional intelligence skills, learn mindfulness techniques, and manage stress, anxiety and sleep issues.

Mental Wellness

Promote a greater awareness and understanding around mental health developing inclusive and healthy environments in which all students and adults can thrive.

Wellness Skills

Create healthy school climates with resources to develop self-awareness, self-management, responsible decision-making, relationship and social awareness skills.

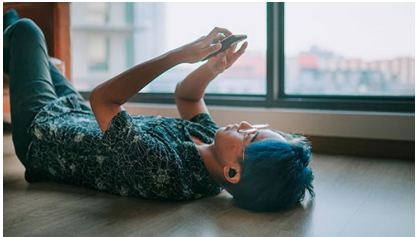



SchoolsPLP Educational Digital Resources

Contract# 024C-WY-104 DR

Matt West 602-349-3693

matt@schoolsplp.com

Welcome to the most innovative online Teaching & Learning Platform available.

Highly Qualified Teachers Duties include monitoring student progress, grading assignments, individual virtual teaching sessions as needed, and responding to messages within 24 hours (Monday – Friday).

Program Coordinators Duties include encouraging the student to succeed, daily monitoring of student progress, daily messages with the student, communication with teachers and stakeholders as needed, and responding to messages within 24 hours (Monday – Friday).

Site Coordinators Duties include collaboration with on-site proctors and district staff to ensure the virtual instruction program is successful. Create plans for students who may be struggling and offer other support strategies for student success and academic achievement

- Does this powerful LMS come with the best content? YES!
- Do these courses allow me to customize content? YES!
- Can I see all my students in one dashboard, regardless of curriculum? YES!
- Can I use a different course design for intervention in this same system? YES!

Research-Based Curriculum Development & Standards Alignment for all student groups including:

1. Hybrid Learners
2. Below Grade Level
3. Intervention/Acceleration
4. Credit Recovery
5. Social & Emotional Learning
6. Special & Alternative Ed

SchoolsPLP & 3D Models!



Our Integrations!





TinyEYE – Teletherapy Services, Mental Health Services,
Speech/Occupational Therapy
MoU62017-NB
Brenda Selk Lang 1.877.846.9393-ext 205
Brenda@TinyEYE.c0m
Nita Werner 307-351-7116 nwerner@newboces.org

Quality Online Therapy Services for Schools

We understand that students may be learning at home, at school, or a combination of both. All providers are licensed to practice in the state services are rendered.

Our dedicated team will ensure all students thrive with online therapy services:

Speech-Language Therapy

Occupational Therapy

School Counselling

Social Work

Educational Psychology



Technology

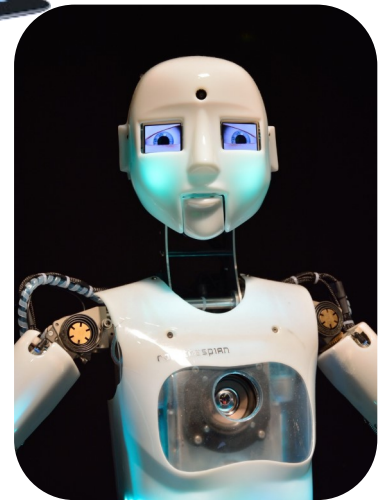



Bluum Technology Catalog of Products and Services

Contract # 2023-009-WY-002

Jay Johnson **C:** 307-287-3758

O: 602-437-7240 x4509

Jay.Johnson@bluum.com

Product Linecard

Audio Visual

Computer Accessories

Computers

Digital Signage

Esports

Furniture

Interactive

Projectors

Software

STEM

Security

Audio Visual Anchor Technologies Audio Enhancement AVer AVerMedia Cleartouch Clevertouch Comprehensive Copernicus Crestron ELMO EPSON FrontRow Hovercam Huddly Jabra Kramer LG Liberty Lumens Merylyn Mind Newline Owl Labs Panasonic Peerless-AV Samsung Screenbeam Sharp Shure SMART ViewSonic

Computer Accessories Anywhere Cart Avid Belkin Bretford Comprehensive Gumdrop Cases Kensington Lockncharge Logitech MAXCases Nutkase ThinkWrite Trox Carts

Computers Acer ASUS HP Kajeet Lenovo Toshiba/Dynabook ViewSonic

Digital Signage Airtame Boxlight BrightSign Carousel Clevertouch LG Peerless-AV Reach Media Systems Rise Vision Screenbeam Touch Pros Vivi

Esports Acer ASUS BrainCo ByteSpeed Lenovo LG Logitech Samsung Spectrum

Furniture Luxor Mein MooreCo Spectrum

Interactive Active Floor AVer Boxlight ClassVR Cleartouch Clevertouch Hovercam LG Lu Interactive Newline Panasonic Samsung Sharp SMART ViewSonic zSpace

Projectors EPSON Panasonic Sharp/NEC ViewSonic

Software Deledao GoGuardian Google for Education Impero Microsoft Securly STEM Fuse

STEM BrainCo ByteSpeed ClassVR Copernicus MakerBot MooreCo SAM Labs Spectrum Fuse Terrapin: Bee-Bot/Blue-Bot UBTECH Wonder Workshop zSpace

Security Axis Communications Managed Methods Milestone Verkada



CDW•G Technology Equipment and Supplies

Contract# 022GWY20261

John Glenn 203-851-7230

johglen@cdwg.com

Stephanie Kessler

kessler@cdw.com

Northeast Wyoming BOCES has chosen to work with AEPA to bring K-12 Public, Charter & Private Schools, Community Colleges & Universities, Public Libraries, City, County & State Governments, and Non-Profits access to CDW•G's extensive catalog. Including, but not limited to, Hardware, Software, Services, and IT Solutions. CDW•G's just-in-time inventory model and multiple distribution centers will ensure you have the products and solutions you need when you need them.

- [Hardware](#)
- [Software](#)
- [Services](#)
- [IT Solutions](#)
- [Brands](#)
- [Research Hub](#)

- Welcome to the CDW•G Purchasing Page for Northeast Wyoming BOCES!

[CDW Premium Page - Northeast Wyoming BOCES \(cdwg.com\)](#)

CDW•G's just-in-time inventory model and multiple distribution centers will ensure you have the products and solutions you need when you need them.

PLEASE NOTE: Certain restrictions apply to the sale of Apple products. Please work with your dedicated account manager for more information.

To place an order via an account manager generated quote:

Enter your quote number in 'Search Quote/Order/PO' and press 'Enter' to retrieve your quote

- Click the 'Add to Cart' button next to your quote
- Continue shopping or Click on 'Transfer Cart' to return to the e-procurement system
- **To find order status, tracking information, and other order-related information:** Enter your order number or PO number in 'Search Quote/Order/PO' and press 'Enter' to retrieve your order

When navigating, click on the CDW•G logo in the upper left-hand corner to return home.

[Cables Computers](#)

[Computer Accessories](#)

[Data Storage Products](#)

[Electronics](#)

[Memory](#)

[Monitors & Projectors](#)

[Networking Products](#)

[Office Equipment & Supplies](#)

[Phones & Video Conferencing](#)

[Power, Cooling & Racks](#)

[Printers, Scanners, & Print Supplies](#)

[Servers & Server Management](#)

• [Analytics Cybersecurity Solutions](#)

[Data Center & Network Infrastructure](#)

[Digital Signage](#)

[Digital Transformation](#)

[Digital Workspace Solutions](#)

[Print Solutions](#)

[Software Management](#)

[IT Solutions by Industry](#)

CPU COMPUTER PROFESSIONALS UNLIMITED

401 E Collins Street

Casper, WY



Computer Professionals Unlimited (CPU)

Technology Catalog Products & Services

Contract # 2023-009-WY-001

Felicia Collins Felicia@cpuiit.com

307-316-7315 Office: 307.235.6212

Khara LeDoux 307-235-6212

khara@307techpros.com

Kyle Gamroth 307-235-6212

kyle@cpuiit.com

Through its 307 Tech Pros services, CPU provides IT solutions that cover your office computers, networks, and email services at all times. We monitor your systems 24/7 so that you can rest assured that we are aware of any issues and are always actively working towards solutions.

Since 1990, CPU has provided Wyoming with the best prices on hardware, software, and IT support. We're an authorized dealer for all major manufacturers. Given our relationships and buying volume, we can almost always save you money on your purchases. And we've launched 307 Tech Pros to offer "white glove service" on all your IT projects.

KEEPING WY IN WYOMING

Think 307 First,
Think Wyoming First

HARDWARE & SOFTWARE

NETWORK & IT MANAGEMENT

CYBERSECURITY

REPAIRS

If you're trying to bring blazing fast internet to your business, home, or community...Mountain West may be your answer. How long have many of us been waiting to get service from the big out-of-state companies? Mountain West serves many parts of Wyoming and is expanding into many others.



HIGH SPEED INTERNET FROM A WYOMING OWNED COMPANY Broadband, Data Center, Commercial, Residential, Community Service



Mtn West
TECHNOLOGIES



Centegix Security Solution Products

Contract# 021G-WY2025-2

Laura McGee [831-247-1471](tel:831-247-1471)

lmcgee@centegix.com

Every. Second. Matters.® Incident response safety solutions for emergencies,

The Foundation of Your Layered Safety Plan: Built for Rapid Incident Response

Accelerate your response to emergencies with the CENTEGIX Safety Platform.

Wearable Mobile Panic Button

Enhanced Visitor Management

Digital Critical Incident Mapping

Reunification for Emergencies

Our strategic integrations work with your existing safety infrastructure to save time coordinating resources and communicating with staff in an emergency.

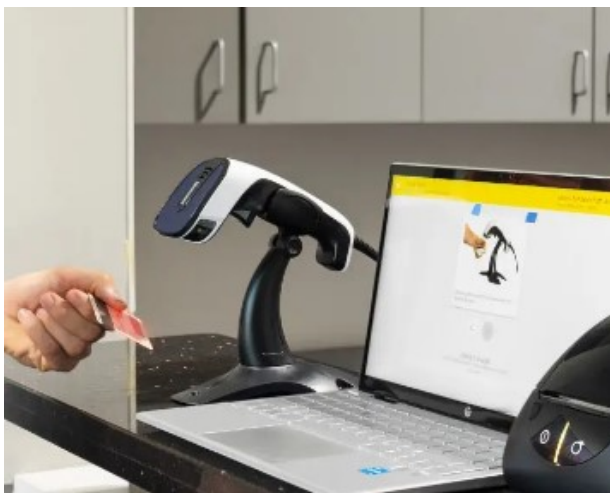

CENTEGIX Solutions Industries Resource

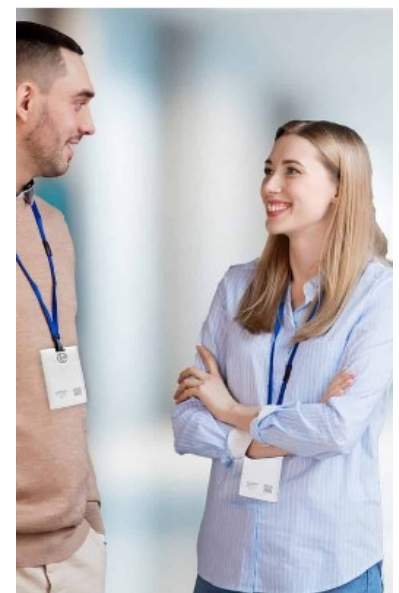

School emergencies happen, and when they do, every second matters. Give your educators peace of mind about their safety so they can focus on what matters most—creating prosperous learning environments.

Discreet duress buttons for healthcare workers and safety solutions for your system empower your team to

Discreet safety solutions for government staff and public servants empower rapid incident response for the every day to the extreme.



Deledao Security Solution Products
Contract# 021G-WY2025-1
Kevin Kuckkan (262) 894-0650
kevin.kuckkan@deledao.com

Our K12 content filter and classroom management solutions automate workflows for busy admins.

Block distractions with real-time AI

Improve your digital classroom management

Keep a pulse on your students' mental wellness





Kajeet Mobil Cellular Connectivity Solutions
 Contract # 0215D-WY202126
 Alison Holz (470) 302-0044 aholz@kajeet.com
 Ryan Stanley rstanley@kajeet.com

Multi-carrier IoT connectivity. Our award-winning Sentinel platform. Private wireless networks. Across public and private sectors, we connect the world for good -- and we do it all with start-to-finish Concierge services that get you up and running quickly and easily.

Whether in class, at home, or enroute, no student should be left behind due to lack of internet access. Our wireless connectivity solutions for education bridge the digital divide to ensure that your students have the access they need, when and where they need it.



Wireless connectivity that keeps systems, people, and communities connected and keeps costs down. From sensors that monitor devices and infrastructure to WiFi solutions that bring connectivity to underserved communities, Kajeet serves the public sector.

Help people get the care they need, where they need it with our multi-carrier approach to connectivity for telehealth and remote patient monitoring (RPM) connected health solution providers and connected health device manufacturers





Total Technology Buy Back IT Program.
Set up your consultation today
wyoing@totaltechnology.com
Contract # 023E-WY-2028-1
Brendan Wittry bwittry@totaltechnology.com
(224) 402-2424

Since our process involves the consultative approach, we have built a team of industry experts. Decades of experience is at your disposal. Whether you are looking to generate funds to buyout a lease, use a cooperative contract, get a quick turnaround to fund your next deployment, or something else that is unique to your situation, our team undoubtedly has experience in it.

What We Offer

TechCycling™ | Data destruction | eRecycling | Program logistics



The backbone of our TechCycling™ services is innovative technology. Whether it's using our analytic software to provide a quick yet accurate quote or building a custom platform to automate the receipt of thousands of individual shipments or employing AI to predict the value of an OEM's devices years out, we use technology to maximize the value of your end-of-life tech. We are more than just a company that disposes of your decommissioned technology. Our TechCycling™ services are the key to getting you the highest value and running a finan-

Sometimes protecting your data means destroying it. With fines associated in data breach increasing, it is more important than ever to destroy the data properly when decommissioning devices. Whether you choose On or Off site hard drive shredding, hard drive erasure, or hard drive degaussing, you can be sure your data is securely destroyed.

When a device owned by your company makes its way to a landfill, bad outcomes for your company could be on the horizon: especially if those devices were asset tagged. Companies like Target or Whole Foods have been hit by fines for improperly disposing of eWaste. Taking appropriate measures with your eWaste should be a priority. Our eRecycling partner network consists of R2V3 (Responsible Recycling) certified companies ensuring your devices never make their way to a landfill.

Logistics can be a weak link in the chain, but it doesn't have to be. Complete chain of custody may be paramount to you in your decision making process when choosing a service provider. From GPS tracking, to secure logistics, to box programs, to white glove logistics solutions, Total Technology's partner network and in-house solutions add layers of security and ease to your project.



Vehicles/EV

Dodge

GMC

Chargers

Ford

Chevy

Jeep

Chrysler





Blink Network LLC Electric Vehicle
 Charging Stations
 Contract# 024B-WY101EV
 Jim Nemec 216-704-5248

BLINK POWERS WHEREVER LIFE TAKES YOU

Blink was founded with the mission to do our part in slowing climate change by reducing greenhouse gas emissions caused by transportation. Our company always has, and continues to be, a driving force in the EV industry. Paving the way for the growth and adaptation of electric vehicles, Blink continues to offer innovative EV products and business partnerships to drive the industry forward.

EV CHARGING FOR FLEETS

Ensure your vehicles are ready for use with a charging network designed to enhance productivity and operational efficiency while lowering energy and

FEDERAL GOVERNMENT EV CHARGING SOLUTIONS

Choose our turnkey program, and our experts will lead you through the entire process of design, engineering, permitting, construction, commissioning, and utility coordination.

Choose Blink for state and local government EV charging programs and fleet management. Blink provides the ultimate solution that empowers you to track vehicle consumption, set fleet rules, and establish charging schedules.



60kW—360kW



Series 9



Series 8



InCharge Energy Inc. Electric Vehicle Charging Stations
Contract# 024B-WY102EV
Laura Rivas 818-253-5086 Laura.Rivas@inchargeus.com

InCharge solutions are specifically tailored to commercial fleets, electric vehicle OEMs, ride share operators, municipalities, and commercial/residential facility owners, as well as automotive dealership operations. InCharge provides a true turnkey solution, to give you peace of mind in this new world of electric powered vehicles.



The new ICE-66 V2X (Vehicle to Everything) charger offers seamless, end-to-end bidirectional and parallel DC Fast charging, with even greater power output.

- Ideal for charging V2G (Vehicle-to-Grid)-compatible vehicles, supporting grants with V2X requirements
- Enhances fleet charging schedule flexibility while maximizing cost efficiency
- Provides simultaneous and asynchronous DC charging and discharging

Optimize fleet operations and maximize savings with [InControl™](#)



ABB Terra 54 & 54 HV

Building on a decade of EV fast charging experience, the Terra 54 offers enhanced usability and reliability in an all-in-one package.

The Terra 54 enables continuous 50 kW charging up to 500 VDC, and the Terra 54HV supports up to 920 VDC – accommodating both CCS1 and CHAdeMO functionality.

ABB Terra 94

This Terra all-in-one DC fast charger offers power up to 90kW. The compact, modular design makes it perfect for retail, highway or fleet use, with power sharing to further optimize utilization.





Melloy Auto Vehicles, Light Duty Trucks, Police, Specialty Vehicles

Contract# 024G-WY-102 Chevy

024G-WY-103 CJDR

024G-WY-104 Ford

Karen Sluga (505)866-3180

karen@melloyfleet.com

Our Order Process:

To get our discussion started provide as much information about the vehicle you need and give us a call.





Pellegriano Auto Group Chevy Vehicles, Electric,
 Light Duty, Sedan, SUV, Trucks, Police, Specialty
 Contract@024G-WY-105-Chevy
 Richard DiRenzo 302-500-3956
fleetman13@gmail.com



TRAX

EQUINOX

TRAVERSE

TRAVERSE LIMITED

BLAZER

TRAILBLAZER

TAHOE

SUBURBAN



SILVERADO 3500 CHASSIS CAB LOW CAB FORWARD EXPRESS PASSENGER /CARGO/ CUTAWAY

BOLT EV BOLT EUV BLAZER EV MALIBU COLORADO

SILVERADO 1500 SIVERADO 1500 LTD SILVERADO HD SILVERADO 3500 HD SILVERADO 2500HD





Peoria Ford Vehicles, Electric, Light Duty, Sedan, SUV,
Trucks, Police, Specialty
Contract# 024G-WY-101
Sandra Gonzalez 602-635-3124
sandra.gonzalez@governmentautosales.com

We believe in **Customer Support, Follow through & Aggressive Inventory**

Multiple Fleet Services – Now you can choose from a full Ford Pro Fleet Management package — or select individual services from the portfolio. Whichever choice you make, Ford Pro allows you to focus on your core business while we manage all your fleet details and provide consolidated billing for top convenience and efficiency

Fleet Management Software

- Tracks fleet data in one place to uncover potential cost reductions
- • Helps optimize vehicle cycling based on asset trends
- • Delivers Fleet Management reporting to help increase visibility into your fleet across the entire organization

Maintenance Management

- Anticipates maintenance needs, monitors repairs and analyzes costs
- Provides expert repair oversight, keeping your fleet vehicles running at their best





Phil Long Dealership Passenger Vehicles, Light Duty Trucks, Police, School Bus, Specialty Vehicles
Contract# WY-20242028
Rhett Butler 505-514-3552
rbutler@phillong.com

Shop By Body

Platform Bodies

Service Bodies

Service Vans

Cargo Vans

Pickups

Cab Chassis





Chalmers Ford Vehicles, Light Duty Trucks,
Police, Specialty Vehicles
Contract# 024G-WY-106
Mike Michnuk
505-554-6447
mmichnuk@chalmersford.com

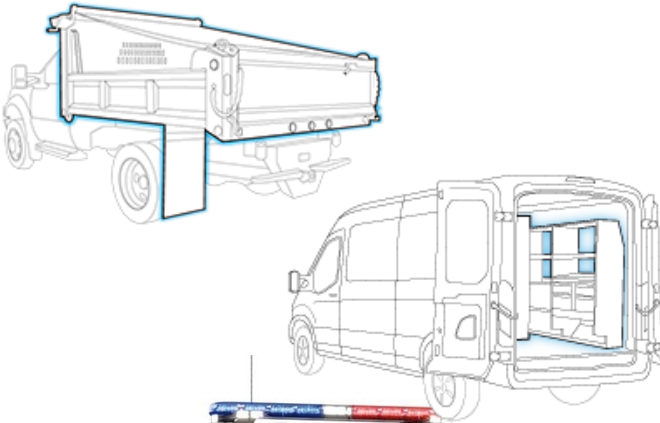

Welcome to Chalmers Ford where specialty vehicles are onsite and ready to upfit for you. You will find an extensive inventory to fit all your needs and any budget. Our sales, service and finance teams are expertly trained and eager to assist you in any way that they can.

For over 23 years, people have been choosing Chalmers Ford for our expertise in customer service and loyalty. Our priority is you, so our goal is always to have the lowest prices, We have REAL VALUE, with fair pricing on our expansive inventory of over 600 new and used cars and an expert team that can help pair you with the right car, truck, or

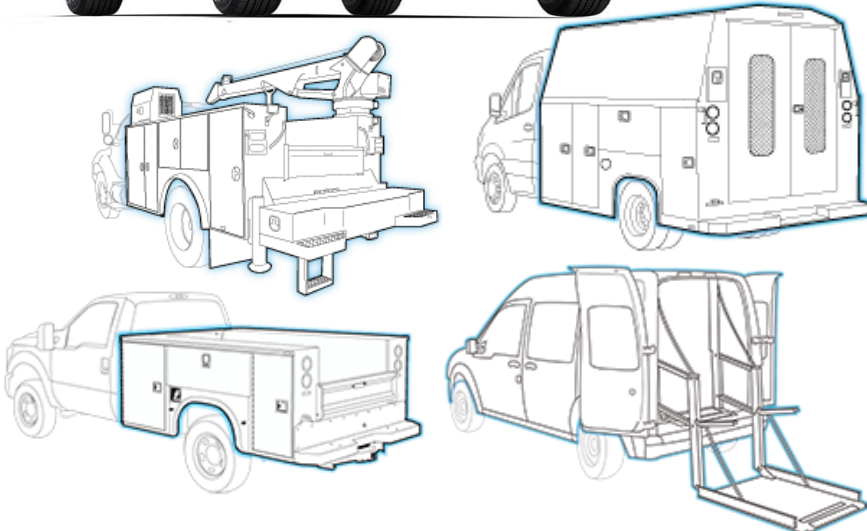

NEW BOCES Cooperative Purchasing Membership Form

Name of Agency: _____

Physical Address: _____

Mailing Address: _____

City State Zip: _____

Contact Person: _____

Phone: _____ Email: _____

Local Newspaper: _____

Contact Person: _____

Phone _____ **Email:** _____

Authorized Signature: _____ Date: _____

Membership Name is for creating an Active Membership list for NEW BOCES Cooperative Consumers for verification to Vendors for approved price discounts. Contact information is not shared or sold it is for updates and proper communication between the Member and NEW BOCES. No fees are required for this membership. The Vendor compensates NEW BOCES 2% when registered members use NEW *BOCES*/ AEPA contracts. Contracts are local and National. Cooperative purchasing of this membership is for Educational Facilities, Non-Profit Organizations, and Government & Municipalities

Send completed form to NEW BOCES

Email: nwerner@newboces.com

Fax: 307-686-7628

USPS: 410 N Miller Avenue, Gillette, WY 82716.

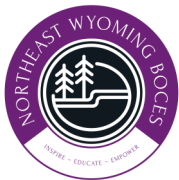

www.newboces.org

Non-Profit Cooperative

NEW BOCES CO-OP is Non-Profit Governmental Agency, created jointly by School Districts, which provides extra services and rebates back to the registered membership.

Interactive Cooperative Purchasing Agreement
Northeast Wyoming Board of Cooperative Educational Services Co-op
(NEW BOCES Co-op)

This AGREEMENT is entered into by and between the undersigned Agency of the State of Wyoming and is effective as to the Agency undersigned as of the date of execution of this AGREEMENT by that party.

Whereas, the parties of this Agreement desire to conserve resources, reduce procurement costs and improve the timely acquisition and cost of supplies, equipment and services; and

Whereas, economies of scale may provide efficiency and economy of procurement; and

Whereas, the parties undersigned have expressed a desire to enter into this intergovernmental Agreement for the purpose of interactive purchasing;

Now, therefore, inconsideration of the mutual promises contained in this Agreement and of the mutual benefits to result therefrom, the parties undersigned agrees to as follows:

Definitions

Interactive Cooperative Purchasing: The cooperative use of supply by participating Agencies of the State of Wyoming associated with the acquisitions of any supplies, equipment or services. Cooperative use of such of agreements shall include the utilization of bids and contracts developed by the issuing party.

Central Repository: Entity responsible for the administration of this agreement. The master Agreement, all exhibits and addenda shall be maintained at the Central Repository. It is the responsibility of the Central Repository to keep all participants apprised of all changes, additions or withdrawals of this agreement.

Issuing Party: The party of this agreement which solicits bids and awards contracts associated with the acquisition of supplies, equipment and services.

Procuring Party: The party of this agreement who utilizes the bids and contracts developed by the issuing party for the acquisition of supplies, equipment and services.

This Agreement shall be effective as to each party undersigned from the date it is executed by that party and shall be automatically extended until such time as that party withdraws from this Agreement. This Agreement will remain in full force and effect as to any party undersigned who has not withdrawn from this Agreement.

All parties to this Agreement shall comply with all federal, state and local laws, rules, regulations, policies, and procedures which are applicable to said parties and to which pertain to this Agreement, including those pertaining to public bidding and procurement. Each procuring party must ensure that its own legal requirements are met prior to participating in any procurement initiated by the issuing party.

Any party may utilize the bids and resulting contracts, this Agreement shall be in accordance with the terms and conditions of said bids and contracts.

The Central Repository of this Agreement shall be:

Northeast Wyoming Board of Cooperative Educational Services (NEW BOCES)
410 N Miller Avenue
Gillette, WY 82716

The Issuing Party of this Agreement shall be:

NEW BOCES Board of Directors
ATTN: Chairman of the Board
410 N Miller Avenue
Gillette, WY 82716

The Procuring Party of this Agreement shall be:

Name:
Address:
City:
Phone:

_____ has entered into an interactive purchasing agreement in order to conserve resources, reduce procurement costs and improve the timely acquisition and costs of supplies, equipment and services. Allowing Vendors whom contracts are awarded to extend the right to purchase supplies, equipment and services pursuant the terms and conditions under contract.

Pursuant to this Agreement the Procuring Party shall:

Make timely payments to the vendor for all supplies, equipment and services received in accordance with established terms and conditions of the procurement. Payment for supplies, equipment and services and inspection and acceptance of materials and services ordered by the procuring party shall be exclusive obligation of such procuring party.

Be responsible for the ordering of all supplies, equipment or services from a vendor under this agreement and shall be responsible for full payment to the vendor of all such supplies, equipment or services. The procuring party shall hold harmless and indemnify the issuing party against any and all claims and/or actions asserted by any vendor against the issuing party as a result of any agreement or contract between the procuring party and the vendor.

Any party to this Agreement may withdraw from participation in this Agreement by providing written notice to the Central Repository. There will not be any property jointly acquired by the parties of this Agreement.

PARTICIPATION ACCEPTANCE

NAME OF PROCURING AGENCY:

PRINT NAME _____ TITLE: _____

SIGNATURE: _____ DATE _____

NAME OF ISSUING PARTY: NEW BOCES Board of Directors

PRINT NAME _____ TITLE: _____

SIGNATURE: _____ DATE _____

Send completed form to NEW BOCES

Email: nwerner@newboces.com

Fax: 307-686-7628

USPS: 410 N Miller Avenue, Gillette, WY 82716.



www.newboces.org

Non-Profit Cooperative

NEW BOCES CO-OP is Non-Profit Governmental Agency, created jointly by School Districts, which provides extra services and rebates back to the registered membership.